

BK3520

Drawn cup needle roller bearing closed end

Schaeffler Kimliği:
0002453720000

Drawn cup needle roller bearings with
closed end BK, to DIN 618/ISO 3245

Teknik bilgiler

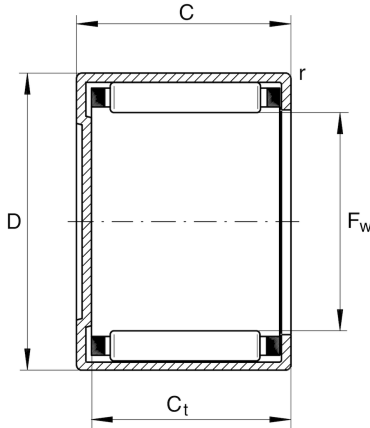

Dimensions

r_{min}	0,8 mm	Minimum chamfer dimension
$C_{t min}$	17,3 mm	Minimum width to base of drawn cup with closed end
	52,805 g	Ağırlık

Main Dimensions & Performance Data

F_w	35 mm	Under roller diameter
D	42 mm	Outside diameter
C	20 mm	Width, outer ring
C_r	23.800 N	Basic dynamic load rating, radial
C_{0r}	46.000 N	Basic static load rating, radial
C_{ur}	6.000 N	Fatigue load limit, radial
n_G	7.500 1/min	Limiting speed
$n_{G Grease}$	4.500 1/min	Limiting speed for grease lubrication
$n_{\vartheta r}$	5.500 1/min	Reference speed

Additional information

SD35X42X4	Sealing ring
G35X42X4	Sealing ring 2
LR30X35X20,5	Suitable inner rings LR
IR30X35X20-XL	Suitable inner rings IR

Temperature range

T_{min}	-30 °C	Operating temperature min.
T_{max}	140 °C	Operating temperature max.