



CSCC055

Deep groove ball bearing

Schaeffler Kimliği:
0071144350000

Deep groove ball bearing, Thin section
bearing CSCC, brass sheet metal cage

Teknik bilgiler

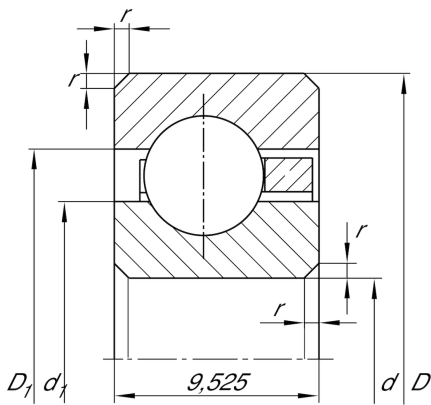

Dimensions

r_{min}	1 mm	Minimum chamfer dimension
d_1	146,7 mm	Shoulder diameter inner ring
D_1	151,7 mm	Shoulder diameter outer ring
	260 g	Ağırlık

Main Dimensions & Performance Data

d	139,7 mm	Bore diameter
d	5.5 inch	Bore diameter (Inch)
D	158,75 mm	Outside diameter
B	9,525 mm	Width
C_r	8.700 N	Basic dynamic load rating, radial
C_{0r}	11.200 N	Basic static load rating, radial
n_G	3.800 1/min	Limiting speed for oil lubrication

Temperature range

T_{min}	-30 °C	Operating temperature min.
T_{max}	120 °C	Operating temperature max.