



CSCC065

Deep groove ball bearing

Schaeffler Kimliği:
0039266480000

Deep groove ball bearing, Thin section
bearing CSCC, brass sheet metal cage

Teknik bilgiler

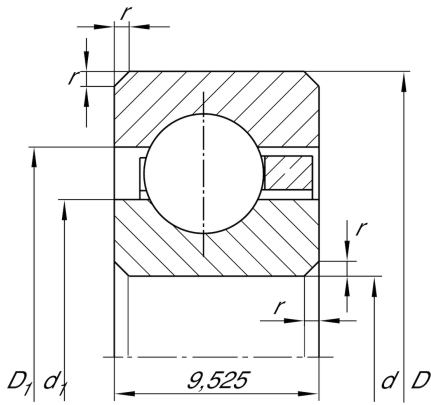

Dimensions

r_{min}	1 mm	Minimum chamfer dimension
d_1	172,1 mm	Shoulder diameter inner ring
D_1	177,1 mm	Shoulder diameter outer ring
	308 g	Ağırlık

Main Dimensions & Performance Data

d	165,1 mm	Bore diameter
d	6.5 inch	Bore diameter (Inch)
D	184,15 mm	Outside diameter
B	9,525 mm	Width
C_r	9.300 N	Basic dynamic load rating, radial
C_{0r}	13.200 N	Basic static load rating, radial
n_G	3.250 1/min	Limiting speed for oil lubrication

Temperature range

T_{min}	-30 °C	Operating temperature min.
T_{max}	120 °C	Operating temperature max.