



CSEB025

Angular contact ball bearing

Schaeffler Kimliği:
0072825240000

Angular contact ball bearing, Thin section
bearing CSEB, brass sheet metal cage

Teknik bilgiler

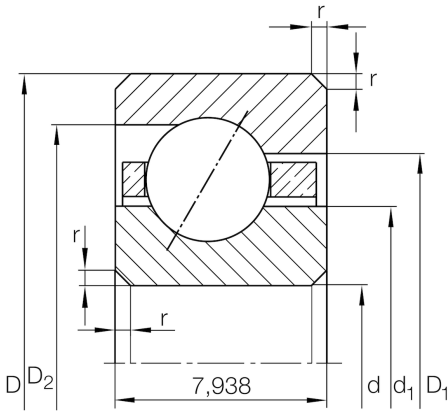

Dimensions

r_{\min}	1 mm	Minimum chamfer dimension
d_1	69,4 mm	Shoulder diameter inner ring
D_1	73,5 mm	Shoulder diameter on outer ring wide side face
D_2	75,3 mm	Shoulder diameter on outer ring small side face
α	30 °	Contact angle
	90 g	Ağırlık

Main Dimensions & Performance Data

d	63,5 mm	Bore diameter
d	2,5 inch	Bore diameter (Inch)
D	79,375 mm	Outside diameter
B	7,938 mm	Width
C_r	5.200 N	Basic dynamic load rating, radial
C_{0r}	5.200 N	Basic static load rating, radial
n_G	8.200 1/min	Limiting speed for oil lubrication

Temperature range

T_{\min}	-30 °C	Operating temperature min.
T_{\max}	120 °C	Operating temperature max.