



CSED060

Angular contact ball bearing

Schaeffler Kimliği:
0096298070000

Angular contact ball bearing, Thin section
bearing CSED, brass sheet metal cage

Teknik bilgiler

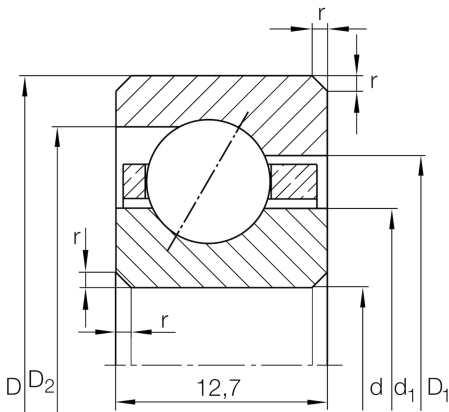

Dimensions

r_{min}	1,5 mm	Minimum chamfer dimension
d_1	161,8 mm	Shoulder diameter inner ring
D_1	168,4 mm	Shoulder diameter on outer ring wide side face
D_2	171,2 mm	Shoulder diameter on outer ring small side face
α	30 °	Contact angle
	0,53 kg	Ağırlık

Main Dimensions & Performance Data

d	152,4 mm	Bore diameter
d	6 inch	Bore diameter (Inch)
D	177,8 mm	Outside diameter
B	12,7 mm	Width
C_r	14.100 N	Basic dynamic load rating, radial
C_{0r}	20.400 N	Basic static load rating, radial
n_G	3.400 1/min	Limiting speed for oil lubrication

Temperature range

T_{min}	-30 °C	Operating temperature min.
T_{max}	120 °C	Operating temperature max.