



CSXA040

Four-point contact bearing

Schaeffler Kimliği:
0028272980000

Four point contact bearing, Thin section
bearing CSXA, brass sheet metal cage

Teknik bilgiler

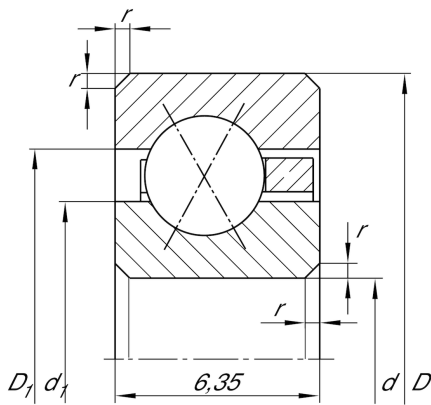

Dimensions

r_{min}	0,6 mm	Minimum chamfer dimension
d_1	106,3 mm	Shoulder diameter inner ring
D_1	109,6 mm	Shoulder diameter outer ring
α	30 °	Contact angle
	76 g	Ağırlık

Main Dimensions & Performance Data

d	101,6 mm	Bore diameter
d	4 inch	Bore diameter (Inch)
D	114,3 mm	Outside diameter
B	6,35 mm	Width
C_r	5.600 N	Basic dynamic load rating, radial
C_{0r}	9.000 N	Basic static load rating, radial
n_G	2.310 1/min	Limiting speed for grease lubrication
n_G	3.300 1/min	Limiting speed for oil lubrication

Temperature range

T_{min}	-30 °C	Operating temperature min.
T_{max}	120 °C	Operating temperature max.