



CSXB035

Four-point contact bearing

Schaeffler Kimliği:
0074724200000

Four point contact bearing, Thin section
bearing CSXB, brass sheet metal cage

Teknik bilgiler

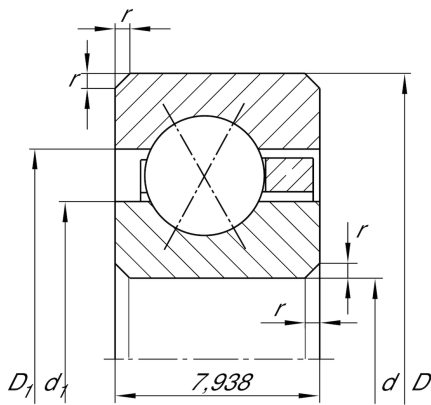

Dimensions

r_{min}	1 mm	Minimum chamfer dimension
d_1	94,8 mm	Shoulder diameter inner ring
D_1	98,9 mm	Shoulder diameter outer ring
α	30 °	Contact angle
	120 g	Ağırlık

Main Dimensions & Performance Data

d	88,9 mm	Bore diameter
d	3.5 inch	Bore diameter (Inch)
D	104,775 mm	Outside diameter
B	7,938 mm	Width
C_r	7.700 N	Basic dynamic load rating, radial
C_{0r}	10.600 N	Basic static load rating, radial
n_G	2.600 1/min	Limiting speed for grease lubrication
n_G	3.750 1/min	Limiting speed for oil lubrication

Temperature range

T_{min}	-30 °C	Operating temperature min.
T_{max}	120 °C	Operating temperature max.