



CSXD070

Four-point contact bearing

Schaeffler Kimliği:
0111776830000

Four point contact bearing, Thin section
bearing CSXD, brass sheet metal cage

Teknik bilgiler

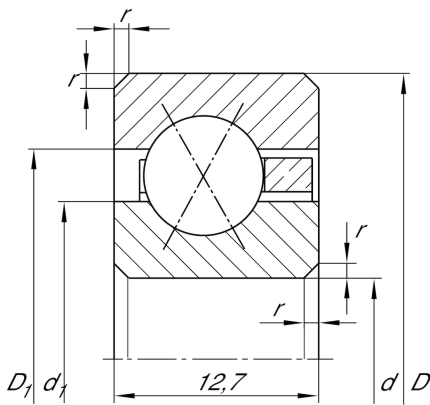

Dimensions

r_{min}	1,5 mm	Minimum chamfer dimension
d_1	187,2 mm	Shoulder diameter inner ring
D_1	193,8 mm	Shoulder diameter outer ring
α	30 °	Contact angle
	0,59 kg	Ağırlık

Main Dimensions & Performance Data

d	177,8 mm	Bore diameter
d	7 inch	Bore diameter (Inch)
D	203,2 mm	Outside diameter
B	12,7 mm	Width
C_r	20.000 N	Basic dynamic load rating, radial
C_{0r}	35.500 N	Basic static load rating, radial
n_G	1.130 1/min	Limiting speed for grease lubrication
n_G	1.620 1/min	Limiting speed for oil lubrication

Temperature range

T_{min}	-30 °C	Operating temperature min.
T_{max}	120 °C	Operating temperature max.