



## CSXD120

### Four-point contact bearing

Schaeffler Kimliği:  
0010359910000

Four point contact bearing, Thin section  
bearing CSXD, brass sheet metal cage

### Teknik bilgiler

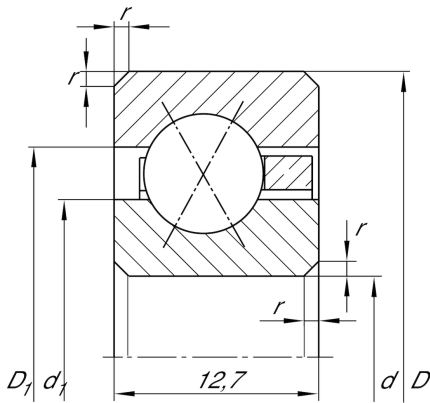

### Dimensions

$r_{min}$	1,5 mm	Minimum chamfer dimension
$d_1$	314,2 mm	Shoulder diameter inner ring
$D_1$	320,8 mm	Shoulder diameter outer ring
$\alpha$	30 °	Contact angle
	1,02 kg	Ağırlık

### Main Dimensions & Performance Data

$d$	304,8 mm	Bore diameter
$d$	12 inch	Bore diameter (Inch)
$D$	330,2 mm	Outside diameter
$B$	12,7 mm	Width
$C_r$	24.200 N	Basic dynamic load rating, radial
$C_{0r}$	60.000 N	Basic static load rating, radial
$n_G$	610 1/min	Limiting speed for grease lubrication
$n_G$	870 1/min	Limiting speed for oil lubrication

### Temperature range

$T_{min}$	-30 °C	Operating temperature min.
$T_{max}$	120 °C	Operating temperature max.