



## CSXD180

### Four-point contact bearing

Schaeffler Kimliği:  
0057677250000

Four point contact bearing, Thin section  
bearing CSXD, brass sheet metal cage

### Teknik bilgiler

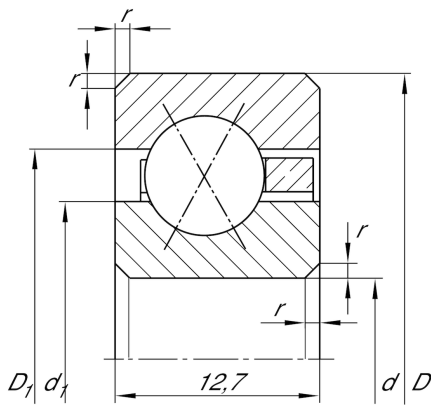

### Dimensions

$r_{min}$	1,5 mm	Minimum chamfer dimension
$d_1$	466,6 mm	Shoulder diameter inner ring
$D_1$	473,2 mm	Shoulder diameter outer ring
$\alpha$	30 °	Contact angle
	1,58 kg	Ağırlık

### Main Dimensions & Performance Data

$d$	457,2 mm	Bore diameter
$d$	18 inch	Bore diameter (Inch)
$D$	482,6 mm	Outside diameter
$B$	12,7 mm	Width
$C_r$	28.000 N	Basic dynamic load rating, radial
$C_{0r}$	90.000 N	Basic static load rating, radial
$n_G$	375 1/min	Limiting speed for grease lubrication
$n_G$	540 1/min	Limiting speed for oil lubrication

### Temperature range

$T_{min}$	-30 °C	Operating temperature min.
$T_{max}$	120 °C	Operating temperature max.