



CSXU070-2RS

Four-point contact bearing

Schaeffler Kimliği:
0036862300000

Four point contact bearing, Thin section bearing CSXU..-2RS, seals, brass sheet metal cage

Teknik bilgiler

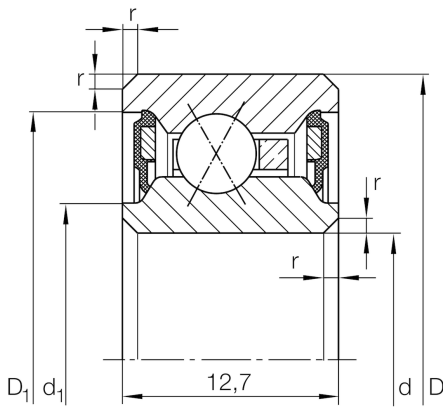

Dimensions

r_{min}	0,38 mm	Minimum chamfer dimension
d_1	181,6 mm	Caliber diameter inner ring
D_1	191,4 mm	Caliber diameter outer ring
α	30 °	Contact angle
	421 g	Ağırlık

Main Dimensions & Performance Data

d	177,8 mm	Bore diameter
d	7 inch	Bore diameter (Inch)
D	196,85 mm	Outside diameter
B	12,7 mm	Width
C_r	12.600 N	Basic dynamic load rating, radial
C_{0r}	24.700 N	Basic static load rating, radial
n_G	2.850 1/min	Limiting speed for grease lubrication

Temperature range

T_{min}	-20 °C	Operating temperature min.
T_{max}	120 °C	Operating temperature max.