

## HK2016

Drawn cup needle roller bearing open end

Schaeffler Kimliği:  
0034363650000

Drawn cup needle roller bearings with  
open ends HK, to DIN 618/ISO 3245

### Teknik bilgiler

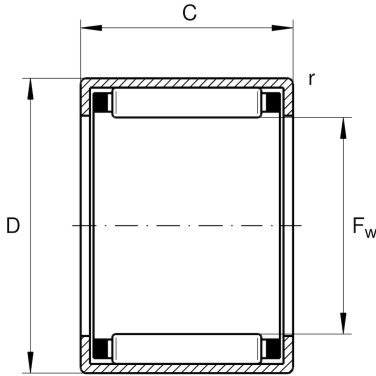

#### Dimensions

$C_1$	16 mm	Width, outer ring
$r_{min}$	0,8 mm	Minimum chamfer dimension
	18,896 g	Ağırlık

#### Main Dimensions & Performance Data

$F_w$	20 mm	Under roller diameter
D	26 mm	Outside diameter
C	16 mm	Width
$C_r$	12.700 N	Basic dynamic load rating, radial
$C_{0r}$	20.100 N	Basic static load rating, radial
$C_{ur}$	2.550 N	Fatigue load limit, radial
$n_G$	12.700 1/min	Limiting speed
$n_{G Grease}$	7.600 1/min	Limiting speed for grease lubrication
$n_{gr}$	9.300 1/min	Reference speed

#### Additional information

SD20X26X4	Sealing ring
G20X26X4	Sealing ring 2
LR17X20X16,5	Suitable inner rings LR
IR17X20X16-XL	Suitable inner rings IR

#### Temperature range

$T_{min}$	-30 °C	Operating temperature min.
$T_{max}$	140 °C	Operating temperature max.