



## CSXC065

### Four-point contact bearing

Schaeffler Kimliği:  
0039280630000

Four point contact bearing, Thin section  
bearing CSXC, brass sheet metal cage

### Teknik bilgiler

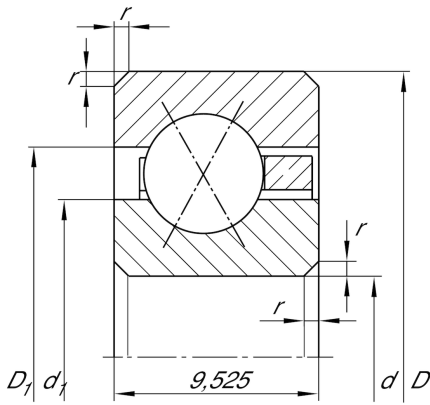

### Dimensions

$r_{min}$	1 mm	Minimum chamfer dimension
$d_1$	172,1 mm	Shoulder diameter inner ring
$D_1$	177,1 mm	Shoulder diameter outer ring
$\alpha$	30 °	Contact angle
	308 g	Ağırlık

### Main Dimensions & Performance Data

$d$	165,1 mm	Bore diameter
$d$	6.5 inch	Bore diameter (Inch)
$D$	184,15 mm	Outside diameter
$B$	9,525 mm	Width
$C_r$	12.400 N	Basic dynamic load rating, radial
$C_{0r}$	23.000 N	Basic static load rating, radial
$n_G$	1.290 1/min	Limiting speed for grease lubrication
$n_G$	1.840 1/min	Limiting speed for oil lubrication

### Temperature range

$T_{min}$	-30 °C	Operating temperature min.
$T_{max}$	120 °C	Operating temperature max.