



CSXC080

Four-point contact bearing

Schaeffler Kimliği:
0047768950000

Four point contact bearing, Thin section
bearing CSXC, brass sheet metal cage

Teknik bilgiler

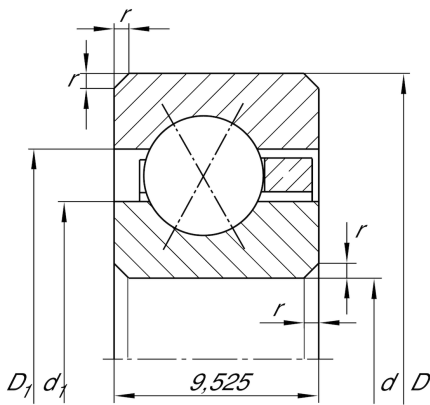

Dimensions

r_{min}	1 mm	Minimum chamfer dimension
d_1	210,2 mm	Shoulder diameter inner ring
D_1	215,2 mm	Shoulder diameter outer ring
α	30 °	Contact angle
	381 g	Ağırlık

Main Dimensions & Performance Data

d	203,2 mm	Bore diameter
d	8 inch	Bore diameter (Inch)
D	222,25 mm	Outside diameter
B	9,525 mm	Width
C_r	13.300 N	Basic dynamic load rating, radial
C_{0r}	28.000 N	Basic static load rating, radial
n_G	1.000 1/min	Limiting speed for grease lubrication
n_G	1.430 1/min	Limiting speed for oil lubrication

Temperature range

T_{min}	-30 °C	Operating temperature min.
T_{max}	120 °C	Operating temperature max.