

NKX30-XL

Needle roller/axial ball bearing

Schaeffler Kimliği:
0506048130000

Needle roller/axial ball bearings NKX, axial component, single direction, to DIN 5429, without end cap, for oil lubrication

X-life

Teknik bilgiler

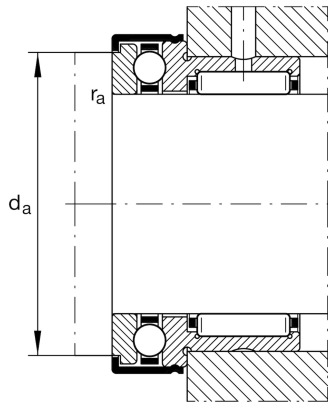
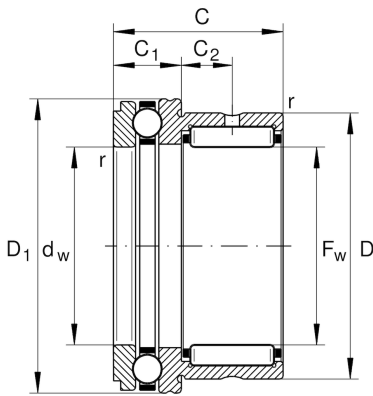

Dimensions

$D_{1\max}$	47,1 mm	Maximum outside diameter flange
$D_{2\max}$	47,1 mm	Maximum outside diameter flange
C_1	11 mm	Width of the axial bearing component
C_1	9,5 mm	Distance to lubrication hole
C_2	9,5 mm	Distance to lubrication hole
d_w	30 mm	Bore diameter of shaft washer
r_{\min}	0,6 mm	Minimum chamfer dimension
	136,85 g	Ağırlık

Main Dimensions & Performance Data

F_w	30 mm	Bore diameter
D	42 mm	Outside diameter
C	30 mm	Height
C_r	25.500 N	Basic dynamic load rating, radial
C_{0r}	36.000 N	Basic static load rating, radial
C_a	20.400 N	Basic dynamic load rating, axial
C_{0a}	42.000 N	Basic static load rating, axial
C_{ur}	6.400 N	Fatigue load limit, radial
C_{ua}	2.090 N	Fatigue load limit, axial
n_G	5.000 1/min	Limiting speed

Mounting dimensions

d_a	42,7 mm	Mounting dimension shaft shoulder
$r_{a\max}$	0,6 mm	Maximum recess radius

Additional information

IR25X30X20-XL

Suitable inner rings IR

Temperature range

T _{min}	-30 °C	Operating temperature min.
T _{max}	120 °C	Operating temperature max.