

NKXR15-Z-XL

Needle roller/axial cylindrical roller bearing

Schaeffler Kimliği:
0507917610000

Needle roller/axial cylindrical roller bearings NKXR..-Z, axial component, single direction, to DIN 5429, with end cap, for grease lubrication

X-life

Teknik bilgiler

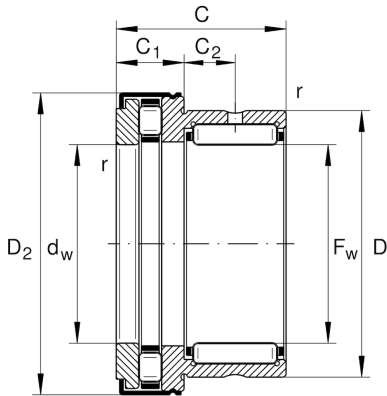
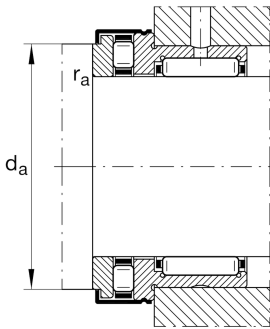

Dimensions

$D_{1\max}$	29,2 mm	Maximum outside diameter flange
$D_{2\max}$	29,2 mm	Maximum outside diameter flange
C_1	9 mm	Width of the axial bearing component
C_2	6,5 mm	Distance to lubrication hole
d_w	15 mm	Bore diameter of shaft washer
r_{\min}	0,3 mm	Minimum chamfer dimension
	44,94 g	Ağırlık

Main Dimensions & Performance Data

F_w	15 mm	Bore diameter
D	24 mm	Outside diameter
C	23 mm	Height
C_r	12.100 N	Basic dynamic load rating, radial
C_{0r}	12.700 N	Basic static load rating, radial
C_a	14.400 N	Basic dynamic load rating, axial
C_{0a}	28.500 N	Basic static load rating, axial
C_{ur}	2.360 N	Fatigue load limit, radial
C_{ua}	4.050 N	Fatigue load limit, axial
n_G	13.000 1/min	Limiting speed
n_{gr}	6.500 1/min	Reference speed

Mounting dimensions

d_a	23,7 mm	Mounting dimension shaft shoulder
$r_{a\max}$	0,3 mm	Maximum recess radius

Additional information

IR12X15X16-XL

Suitable inner rings IR

Temperature range

T _{min}	-30 °C	Operating temperature min.
T _{max}	120 °C	Operating temperature max.