

NKXR17-Z-XL

Needle roller/axial cylindrical roller bearing

Schaeffler Kimliği:
0507917700000

Needle roller/axial cylindrical roller bearings NKXR..-Z, axial component, single direction, to DIN 5429, with end cap, for grease lubrication

X-life

Teknik bilgiler

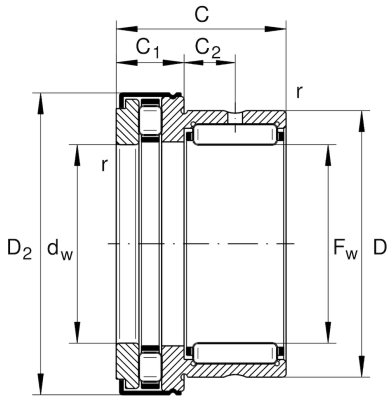
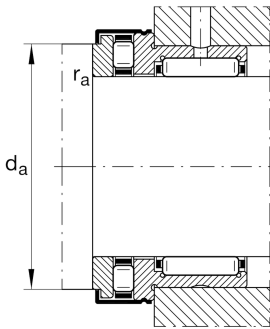

Dimensions

$D_{1\max}$	31,2 mm	Maximum outside diameter flange
$D_{2\max}$	31,2 mm	Maximum outside diameter flange
C_1	9 mm	Width of the axial bearing component
C_2	8 mm	Distance to lubrication hole
d_w	17 mm	Bore diameter of shaft washer
r_{\min}	0,3 mm	Minimum chamfer dimension
	53,68 g	Ağırlık

Main Dimensions & Performance Data

F_w	17 mm	Bore diameter
D	26 mm	Outside diameter
C	25 mm	Height
C_r	13.500 N	Basic dynamic load rating, radial
C_{0r}	15.000 N	Basic static load rating, radial
C_a	16.000 N	Basic dynamic load rating, axial
C_{0a}	33.500 N	Basic static load rating, axial
C_{ur}	2.800 N	Fatigue load limit, radial
C_{ua}	4.700 N	Fatigue load limit, axial
n_G	12.000 1/min	Limiting speed
n_{gr}	5.500 1/min	Reference speed

Mounting dimensions

d_a	25,7 mm	Mounting dimension shaft shoulder
$r_{a\max}$	0,3 mm	Maximum recess radius

Additional information

IR14X17X17-XL

Suitable inner rings IR

Temperature range

T _{min}	-30 °C	Operating temperature min.
T _{max}	120 °C	Operating temperature max.